

JVC

SCHEMATIC DIAGRAMS

COMPACT COMPONENT SYSTEM

HX-Z1

CD-ROM No.SML200206

Area Suffix

J U.S.A.
C Canada

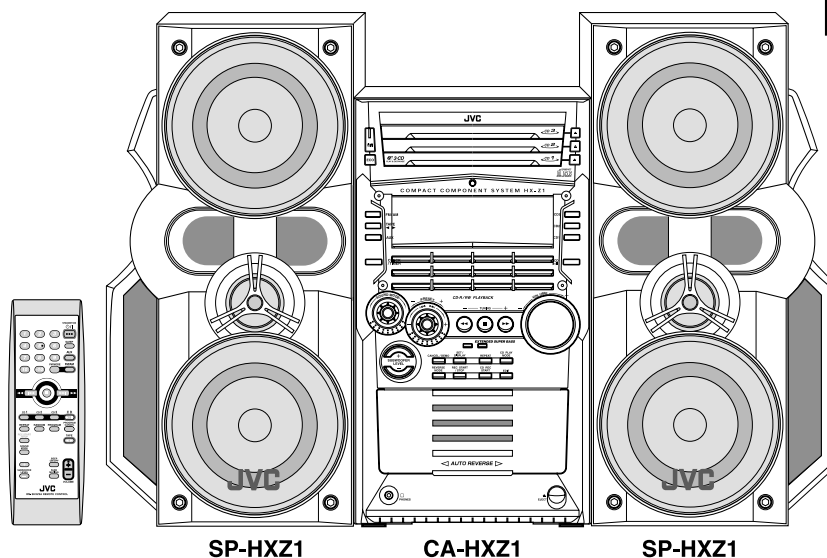

SP-HXZ1

CA-HXZ1

SP-HXZ1

COMPACT
disc
DIGITAL AUDIO

Contents

Block diagram	2-1
Standard schematic diagrams	2-2
Printed circuit boards	2-10~16

Block diagram

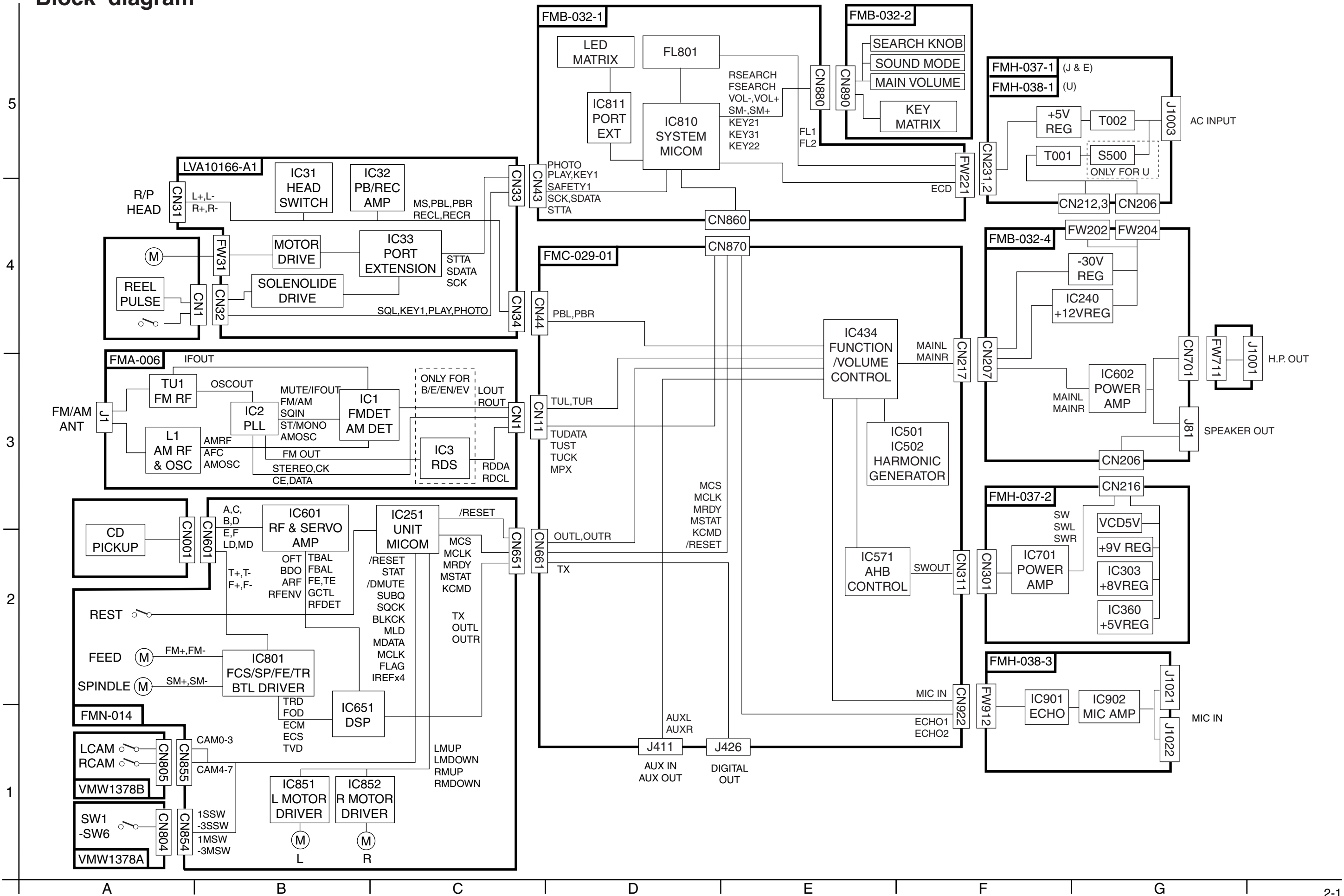

Standard schematic diagrams

Front circuit

5

4

3

2

1

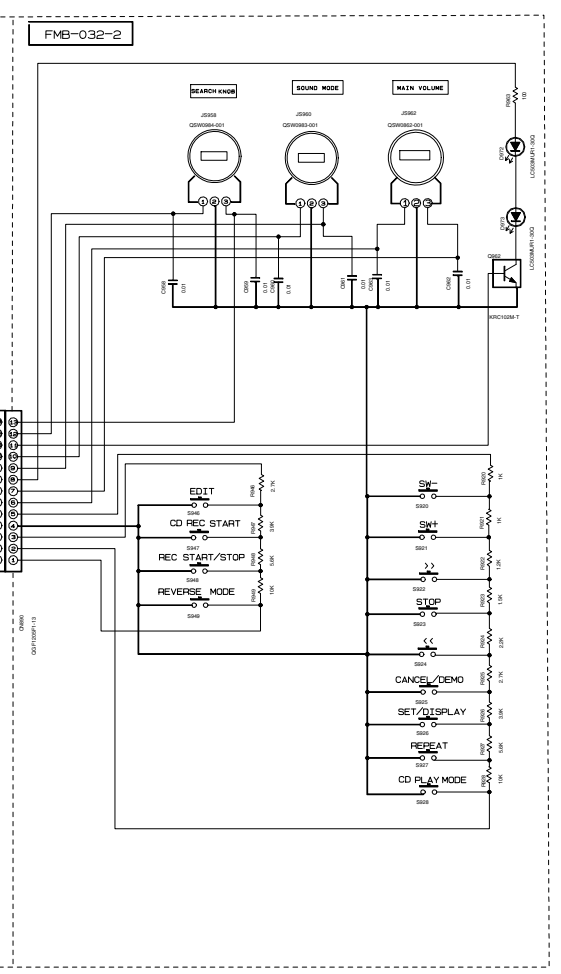
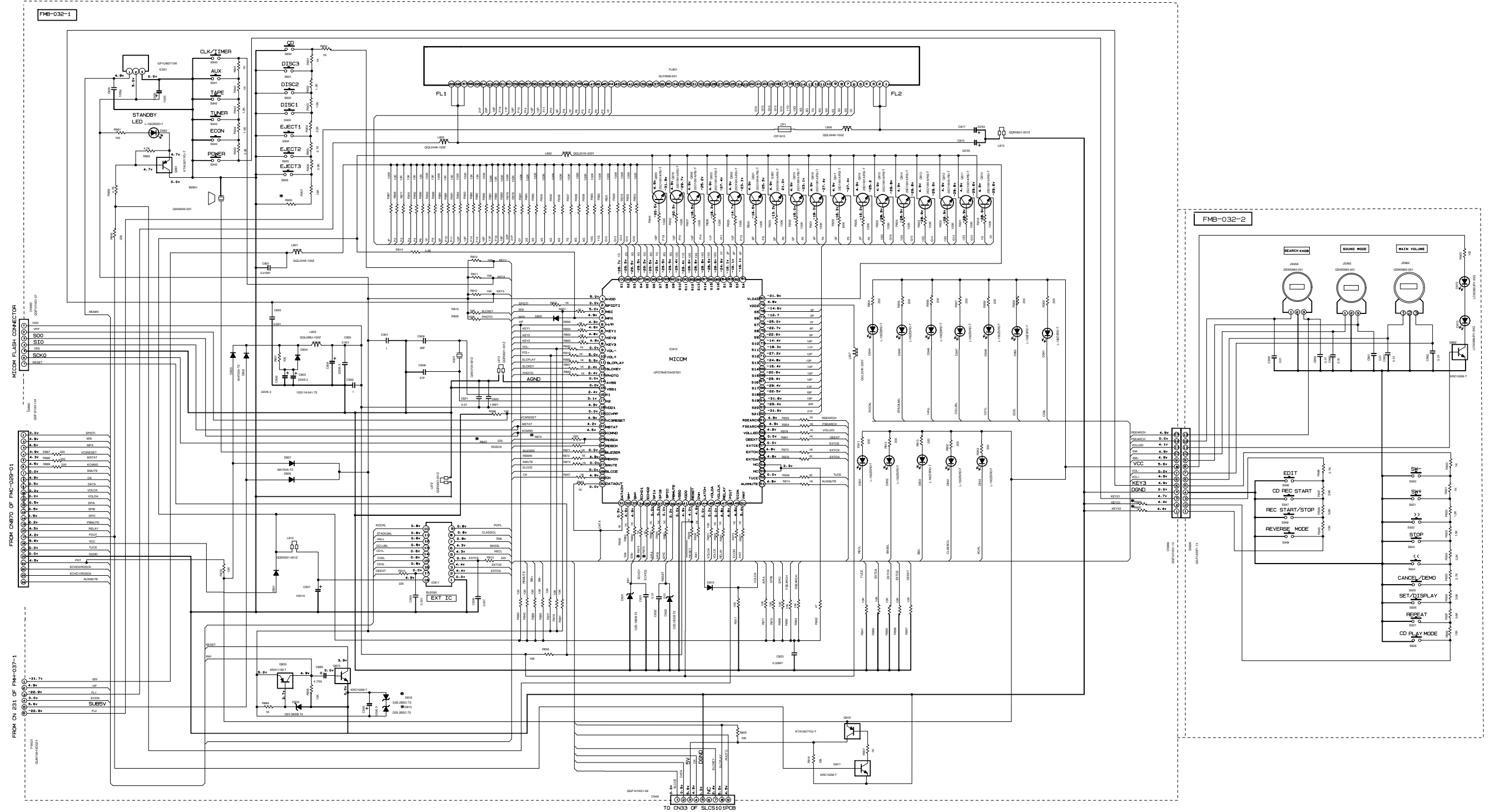

MARK	HXZ-1					HXZ-3				
	B-E-EN-EV	A	J-C	U-UJ-UT-UW	UY	B-E-EN-EV	A	J-C	U-UJ-UT-UW	UY
R909	330K	330K	330K		330K	75K	75K	75K		75K
R929	75K	330K	330K	330K	75K	75K	330K	330K	330K	75K
R950	330K	18K	330K	75K	330K	330K	18K	330K	75K	75K
RB43, RB70	USE	NONE	NONE	NONE	NONE	USE	NONE	NONE	NONE	NONE
RB74, RB75	NONE	NONE	NONE	USE	USE	NONE	NONE	NONE	USE	USE
DB15, DB16	DZ6, 2B5C-T2	DZ6, 2B5C-T2	NONE	NONE	NONE	DZ6, 2B5C-T2	DZ6, 2B5C-T2	NONE	NONE	NONE

NOTE: FOR VCD MODEL CB40 CHANGE TO 100/10 AND REPLACE BB150 BY 68 OHM RESISTOR

NOTES

- VOLTAGES ARE DC-MEASURED WITH A DIGITAL VOLT METER OR OSCILLOSCOPE WITHOUT INPUT SIGNAL. CONDITION — AUX MODE- VOL. MIN- BASS OFF
- UNLESS OTHERWISE SPECIFIED:
 - RESISTORS ARE 1/4W ± 5% CARBON RESISTOR.
 - ALL RESISTANCE VALUES ARE IN OHMS.
 - ALL CAPACITORS ARE CERAMIC CAPACITOR OR MYLAR CAPACITOR.
 - ALL CAPACITANCE VALUES ARE IN PICO(F).
 - ALL INDUCTANCE VALUES ARE IN HENRY(H).
 - ALL CAPACITORS ARE SHOWN IN THE FORM OF CAPACITANCE (μF)/RATED VOLTAGE (V).
 - ALL DIODES ARE 1SS119-041-T2
 - ALL TACT SWITCH ARE 0260674-0012

■ Main circuit

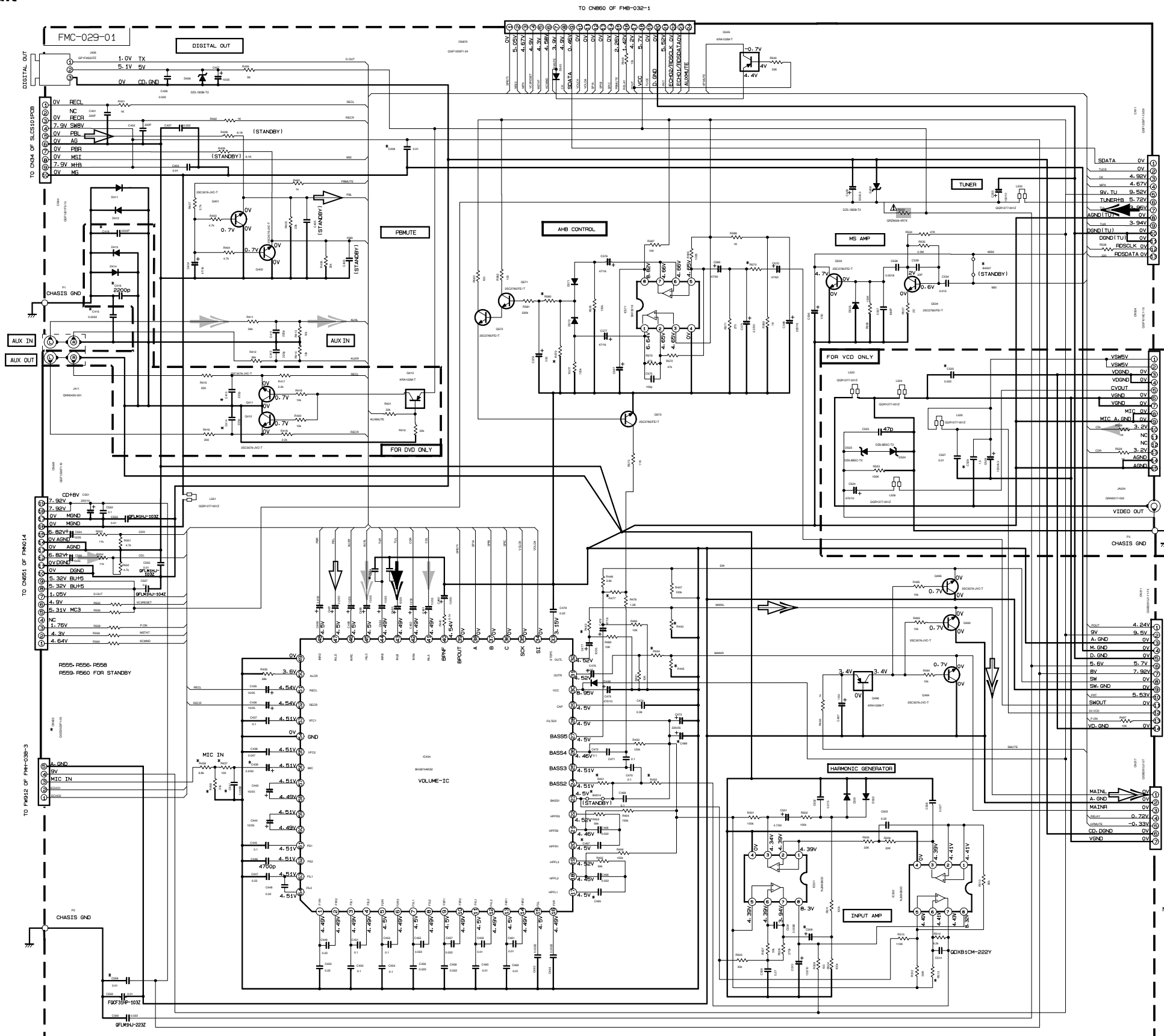

MARK #

MODEL	HXZ1 & HXZ3				
VERSION	J/C	B/E EN/EV	A	UT/UW U/UU	UY
C408	NONE	FGCF3HP-103Z			NONE
C558	NONE	FGCF3HP-103Z			NONE
C563	NONE	QDYB1CM-103Y			NONE
C564	NONE	QDYB1CM-103Y			NONE
R477	GRE141J-123Y	GRE141J-123Y			GRE141J-682Y
R538	NONE	GRE141J-221Y			NONE
CN922	NONE	NONE		GD0503F1-05	NONE
CN870	GGF1205F1-21	GGF1205F1-23	GGF1205F1-21	GGF1205F1-21	GGF1205F1-21
CN11	GGF1205F1-09	GGF1205F1-13	GGF1205F1-09	GGF1205F1-09	GGF1205F1-09
R436	NONE	NONE			GRE141J-682Y
R437	NONE	NONE			GRE141J-101Y
R438	NONE	NONE			GRE141J-513Y
C439	NONE	NONE			GETN1HM-225Z
C441	NONE	NONE			GLFM1HJ-682Z

MARK #

MODEL	HX-Z1		HX-Z3	
VERSION	J/C/A/B/E/EN UT/UW/UU/UY		J/C/A/B/E/EN UT/UW/UU/UY	
R442	GRE141J-682Y		GRE141J-472Y	
R443	GRE141J-243Y		GRE141J-103Y	
R444	GRE141J-682Y		GRE141J-472Y	
R445	GRE141J-243Y		GRE141J-103Y	
R451	GRE141J-183Y		GRE141J-153Y	
R452	GRE141J-682Y		GRE141J-822Y	
R513	GRE141J-103Y		GRE141J-822Y	
R570	GRE141J-562Y		GRE141J-622Y	
R579	GRE141J-154Y		GRE141J-224Y	
R580	GRE141J-682Y		GRE141J-223Y	
C465	GGF32AJ-223Z		GF20160-223Z	
C467	GGF32AJ-223Z		GF20160-223Z	
C469			QTE1C06-472Z	
C509	GETN1HM-475Z		GETN1CM-106Z	

	REFERENCE NUMBER	POSITION
TAPE	401 - 409	
AUX IN	410 - 421	
DIGITAL OUT	426 - 427	
VOLUME IC	434 - 499	
SUPPLY	493 - 497	
HARMONIC GENERATOR	501 - 515	
VCD	523 - 529	
TUNER	533 - 539	
TO FMB	545 - 548	
VIDEO	551 - 560	
AHB CONTROL	570 - 588	

NOTES

- VOLTAGES ARE DC-MEASURED WITH A DIGITAL VOLT METER OR OSCILLOSCOPE WITHOUT INPUT SIGNAL.
CONDITION — AUX KEYS: VOL. MDN. SUBWOOFER VOL. 1.
- UNLESS OTHERWISE SPECIFIED:
RESISTORS ARE 1/4W ±5% CARBON RESISTOR.
ALL RESISTANCE VALUES ARE IN OHM (Ω).
ALL CAPACITORS ARE CERAMIC CAPACITOR OR MYLAR CAPACITOR.
ALL CAPACITANCE VALUES ARE IN PICO(F).
ALL INDUCTANCE VALUES ARE IN MICRO(H).
ALL CAPACITORS ARE SHOWN IN THE FORM OF CAPACITANCE (μF)/RATED VOLTAGE (V).
ALL DIODES ARE 1SS119-041-12.

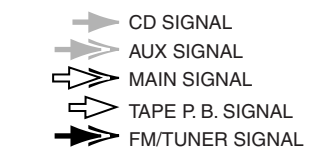

▲ Parts are safety assurance parts.
When replacing those parts make sure to use the specified one.

5
4
3
2
1

A B C D E F G 2-3

Power amplifier & Power supply circuit

5
4
3
2
1

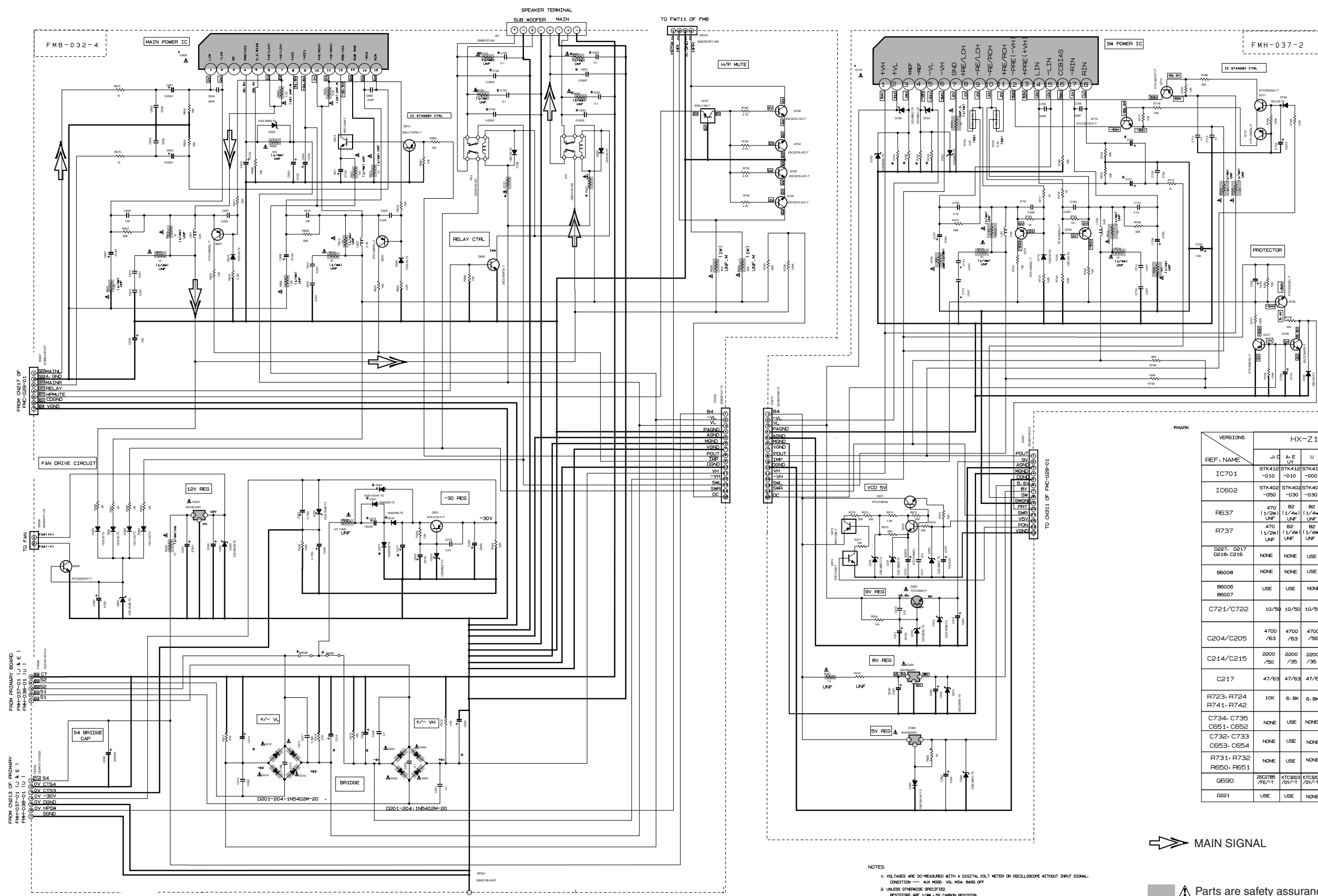

VERSIONS REF. NAME	HX-Z1				HX-Z3			
	J-C	A-E	U	UT	J-C	A-E	U	UT
IC701	STK412-010	STK412-010	-000	STK412-000	STK412-020	STK412-010	STK412-010	STK412-010
IC602	STK402-050	STK402-030	STK402-030	STK402-030	STK402-070	STK402-050	STK402-050	STK402-050
R637	470 (1/2W) UNF	82 (1/4W) UNF	82 (1/4W) UNF	82 (1/4W) UNF	470 (1/2W) UNF	82 (1/4W) UNF	82 (1/4W) UNF	82 (1/4W) UNF
R737	470 (1/2W) UNF	82 (1/4W) UNF	82 (1/4W) UNF	82 (1/4W) UNF	470 (1/2W) UNF	82 (1/4W) UNF	82 (1/4W) UNF	82 (1/4W) UNF
D227, D217 D218, C216	NONE	NONE	USE	USE	NONE	NONE	USE	USE
B6008	NONE	NONE	USE	NONE	NONE	NONE	USE	NONE
B6006 B6007	USE	USE	NONE	USE	USE	NONE	USE	USE
C721/C722	10/50	10/50	10/50	10/50	10/35	10/35	10/35	10/35
C204/C205	4700 /63	4700 /63	4700 /56	4700 /56	4700 /63	4700 /63	4700 /63	4700 /63
C214/C215	2200 /50	2200 /35	2200 /35	2200 /35	2200 /50	2200 /50	2200 /50	2200 /50
C217	47/63	47/63	47/63	47/63	47/100	47/100	47/100	47/100
R723, R724 R741, R742	10K	6.8K	6.8K	6.8K	10K	6.8K	6.8K	6.8K
C734, C735 C651, C652	NONE	USE	NONE	NONE	USE	NONE	NONE	NONE
C732, C733 C653, C654	NONE	USE	NONE	NONE	USE	NONE	NONE	NONE
R731, R732 R650, R651	NONE	USE	NONE	NONE	USE	NONE	NONE	NONE
Q690	2SC785 /RE-1	KTC3003 /OV-1	KTC3003 /OV-1	KTC3003 /RE-1	2SC785 /RE-1	KTC3003 /OV-1	KTC3003 /OV-1	KTC3003 /OV-1
D221	USE	USE	NONE	NONE	USE	USE	NONE	NONE

MAIN SIGNAL

NOTES
 1. VOLTAGES ARE DC-MEASURED WITH A DIGITAL VOLT METER OR OSCILLOSCOPE WITHOUT INPUT SIGNAL. CONDITION — AUX MODE, VOL. MIN, BASS OFF
 2. UNLESS OTHERWISE SPECIFIED RESISTORS ARE 1/4W ± 5% CARBON RESISTOR. ALL RESISTANCE VALUES ARE IN OHM Ω. ALL CAPACITORS ARE CERAMIC CAPACITOR OR MILAR CAPACITOR. ALL CAPACITANCE VALUES ARE IN pF (PF). ALL INDUCTANCE VALUES ARE IN mH (MH). ALL CAPACITORS ARE SHOWN IN THE FORM OF CAPACITANCE (μF/RATED VOLTAGE (V)).

Parts are safety assurance parts. When replacing those parts make sure to use the specified one.

A B C 2-4 D E F G

CD control circuit

5

4

3

2

1

A

B

C

D

E

F

G

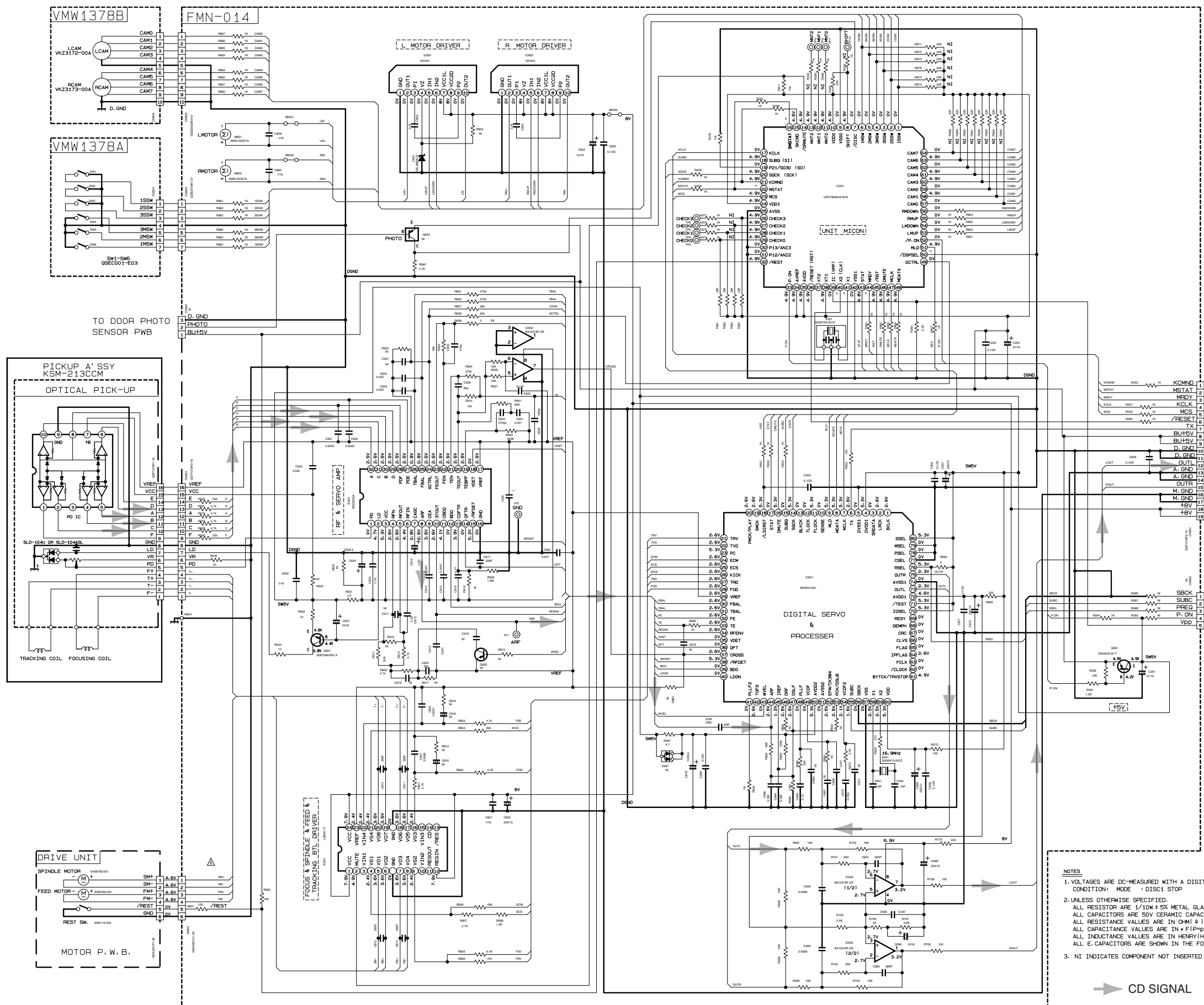

- NOTES
1. VOLTAGES ARE DC-MEASURED WITH A DIGITAL VOLT METER
CONDITION: MODE : DISC1 STOP
 2. UNLESS OTHERWISE SPECIFIED.
ALL RESISTOR ARE 1/10W ± 5% METAL GLAZE RESISTOR.
ALL CAPACITORS ARE 50V CERAMIC CAPACITOR OR 50V MYLAR CAPACITOR.
ALL RESISTANCE VALUES ARE IN OHM (Ω).
ALL CAPACITANCE VALUES ARE IN PICO-FARAD (pF).
ALL INDUCTANCE VALUES ARE IN HENRY (H).
ALL E-CAPACITORS ARE SHOWN IN THE FORM OF CAPACITANCE (μF) / RATED VOLTAGE (V).
 3. NI INDICATES COMPONENT NOT INSERTED

➔ CD SIGNAL

TO CHASSIS 1 OF PWC-003-1

■ Cassette amplifier circuit

5
4
3
2
1

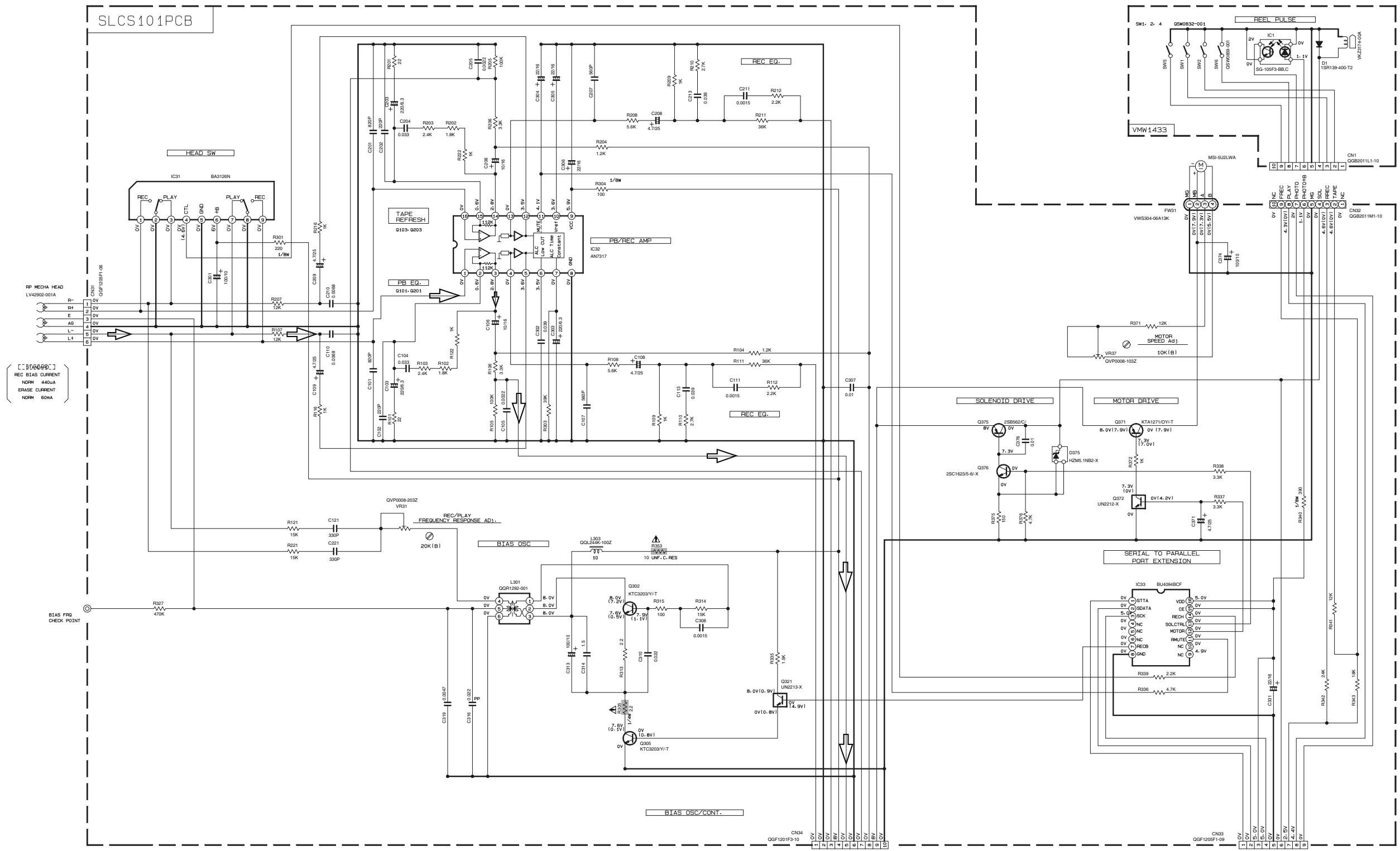

NOTES

- VOLTAGES ARE DC-MEASURED WITH A DIGITAL VOLT METER OR OSCILLOSCOPE WITHOUT INPUT SIGNAL. CONDITION: MEDIA STOP MODE.
- UNLESS OTHERWISE SPECIFIED - RESISTORS ARE 1/10W ±5% METAL GLAZE RESISTOR. ALL RESISTANCE VALUES ARE IN OHM(S). ALL CAPACITORS ARE CERAMIC CAPACITOR OR MYLAR CAPACITOR. ALL CAPACITANCE VALUES ARE IN #F(PH#P). ALL INDUCTANCE VALUES ARE IN #H(M#MH). ALL E. CAPACITORS ARE SHOWN IN THE FORM OF CAPACITANCE (#F1)/RATED VOLTAGE (V). POLYPROPYLENE CAPACITOR.

PARTS	NAME	REF. NO
	F41A4Z or DTC147KA	G101-G201
	F41L4M or DTC144EXA	G321
	F41F4M or DTC124EXA	G372

TO CN43 OF FMB-032-1

➔ TAPE P. B. SIGNAL

▲ Parts are safety assurance parts. When replacing those parts make sure to use the specified one.

TO CN44 OF FMC-029-01

■ Tuner circuit

NOTES

1. VOLTAGES ARE DC-MEASURED WITH A DIGITAL VOLT METER.
2. ALL RESISTORS ARE 1/8W ±5% METAL GLAZE RESISTOR.
3. ALL RESISTANCE VALUES ARE IN OHM(Ω).
4. ALL CAPASITANCE VALUES ARE IN #F(P=pF).
5. ALL E-CAPASITORS ARE SHOWN IN THE FORM OF CAPASITANCE (#F)/RATED VOLTAGE (V).
6. SI DIODES (D) ARE ALL 1SS133-T THAT CAN BE CHANGED TO SIMILAR DIODE SUCH AS MA165 OR HSS104J.
7. PARTS NO. OF TRANSISTORS ARE AS FOLLOWS.
Q1 2SC2814/4-5/-X Q2-Q3 2SC2412K/R/-X
Q4-Q5 DTA114YKA-X

B. INSIDE OF DIGITAL TRANSISTORS ARE SHOWN AS FOLLOWS.

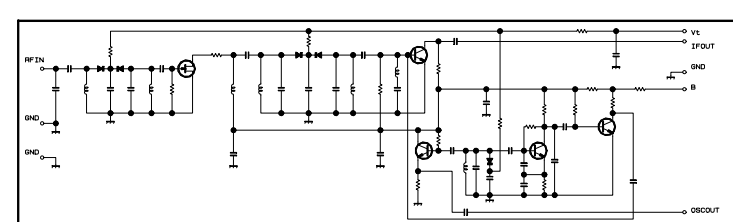
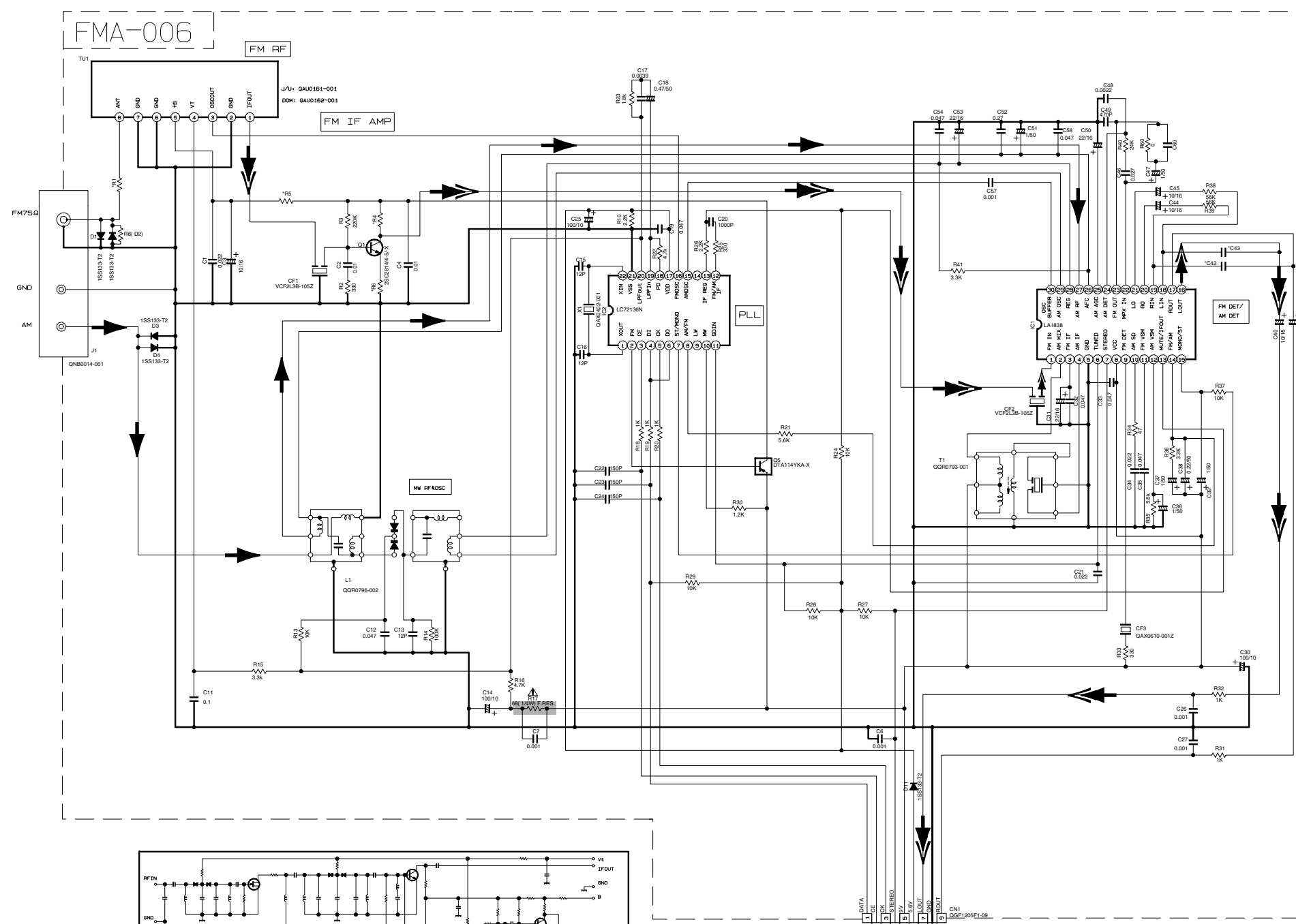
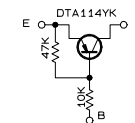

VERSION			
J/C	User188	ROM LK MODEL	SK-F
C48	0.0028	0.0015	0.0018
C49	0.0022	0.0015	0.0018
R1	560	560	270
R4	331	331	221
R5	560	560	270
R6	240	240	180
R8	D2	D2	101

CONDITION	PIN NO.	1	2	3	4	5	6	7	8	9	10	11	12	13	14	15	16	17	18	19	20	21	22	23	24	25	26	27	28	29	30
IC1	FM NO SIGNAL	3.6	8.9	3.6	3.6	0	5.0	5.0	8.9	8.9	1.3	0.1	0	0.9	7.8	7.8	4.3	4.3	4.3	4.3	3.4	3.4	2.8	3.4	0	0	3.6	3.6	3.6	2.7	
	FM 60dB STEREO	3.6	8.9	3.6	3.6	0	0	5.0	8.9	8.9	1.3	4.3	0	0.9	7.8	7.8	4.3	4.3	4.3	4.3	3.4	3.4	2.8	3.4	0	0	3.6	3.6	3.6	2.7	
	AM NO SIGNAL	3.5	9.0	3.5	3.5	0	5.0	5.1	9.0	2.6	1.3	0	0	0.9	4.7	5.5	4.3	4.3	4.3	4.3	3.3	3.2	2.8	1.8	0.7	0.7	3.6	3.6	3.6	2.1	
IC2	FM NO SIGNAL	2.5	0	0	5.0	4.9	5.0	7.9	7.8	3.6	6.1	5.1	0	0	0	0	2.5	5.1	0.9	0.9	3.8	0	2.3								

Tr. NO.	Q1	Q5				
PIN NO.	E	C	B	E	C	B
FM 87.5MHz NO SIGNAL	0	7.1	0.85	8.9	8.8	0
AM 522kHz NO SIGNAL	0	0	0	9.0	0	8.9

Tr. NO.	Q2	Q3	Q4			
PIN NO.	E	C	B	E	C	B
AM 522kHz NO SIGNAL	0	0	0.7	0	0.7	0
AM 144kHz NO SIGNAL	0	0	0.3	0	0.3	0.3

➔ AM SIGNAL
➔ FM/TUNER SIGNAL

⚠ Parts are safety assurance parts. When replacing those parts make sure to use the specified one.

5
4
3
2
1

A B C D E F G 2-7

■ Mic & Head phone circuit

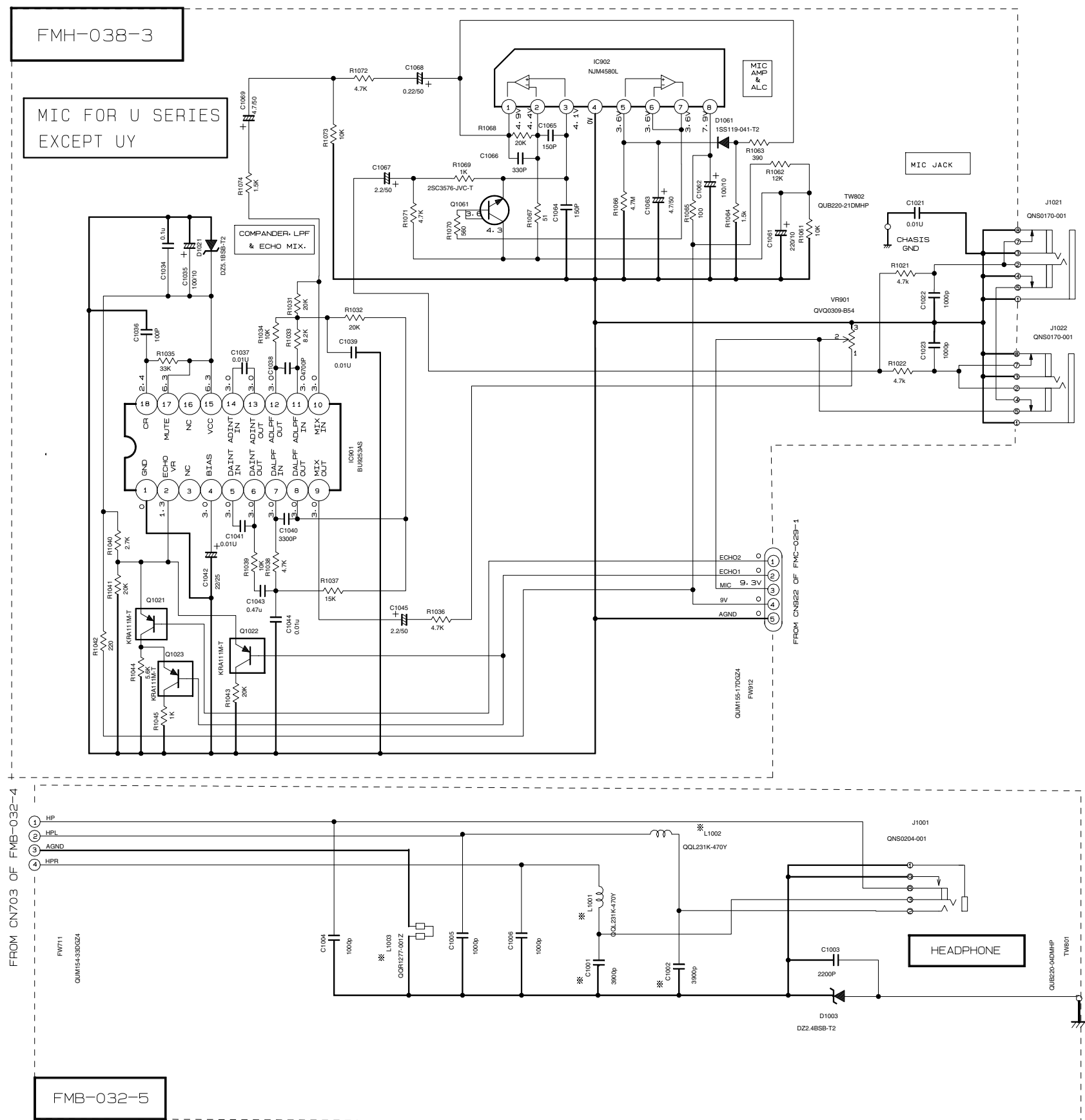

* MARK	L 1001, L 1002	C 1001, C 1002	L 1003
B, E, EN, EV	QQL231K-470Y	3900P	QQR1277-001Z
A	QQL231K-470Y	3900P	QQR1277-001Z
J, C	SHORT	NONE	QQL231K-2R2Y
U, UJ, UT, UW	SHORT	NONE	QQL231K-2R2Y
UY	SHORT	NONE	QQL231K-2R2Y

* MARK	L 1001, L 1002	C 1001, C 1002	L 1003
B, E, EN, EV	QQL231K-470Y	3900P	QQR1277-001Z
A	QQL231K-470Y	3900P	QQL231K-2R2Y
J, C	SHORT	NONE	QQL231K-2R2Y
U, UJ, UT, UW	SHORT	NONE	QQL231K-2R2Y
UY	SHORT	3900P	QQL231K-2R2Y

NOTES

- VOLTAGES ARE DC-MEASURED WITH A DIGITAL VOLT METER OR OSCILLOSCOPE WITHOUT INPUT SIGNAL. CONDITION --- AUX MODE, ECHO OFF
- UNLESS OTHERWISE SPECIFIED
RESISTORS ARE 1/4W ± 5% CARBON RESISTOR. ALL RESISTANCE VALUES ARE IN OHM (Ω). ALL CAPACITORS ARE CERAMIC CAPACITOR OR MYLAR CAPACITOR. ALL CAPACITANCE VALUES ARE IN #F (P=pF). ALL INDUCTANCE VALUES ARE IN #H (m=mH). ALL E. CAPACITORS ARE SHOWN IN THE FORM OF CAPACITANCE (F/RATED VOLTAGE (V).

5

4

3

2

1

A

B

C

2-8 D

E

F

G

Printed circuit boards

■ Main board

5

4

3

2

1

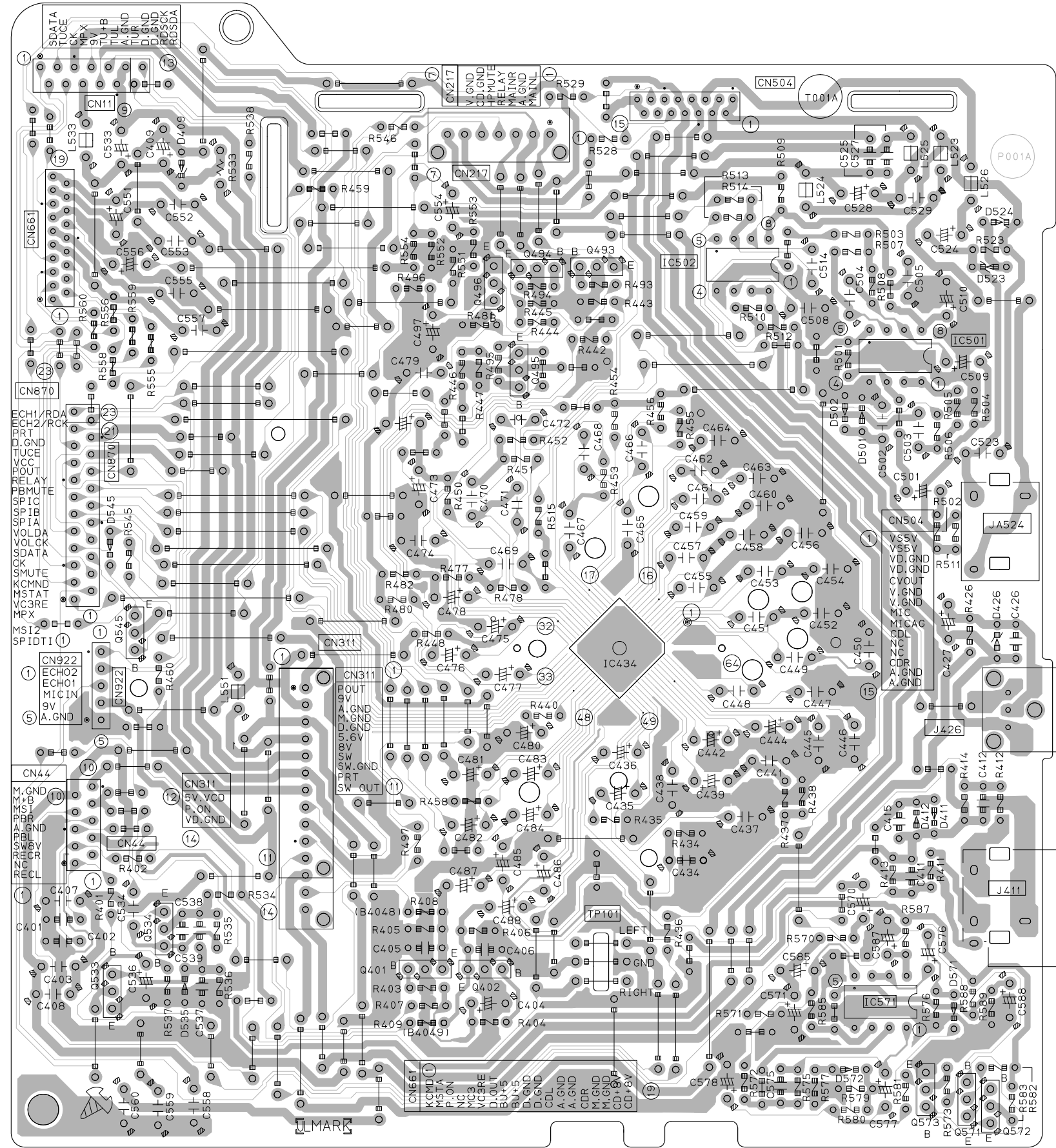

A

B

C

2-10 D

E

F

G

■ Front board

5

4

3

2

1

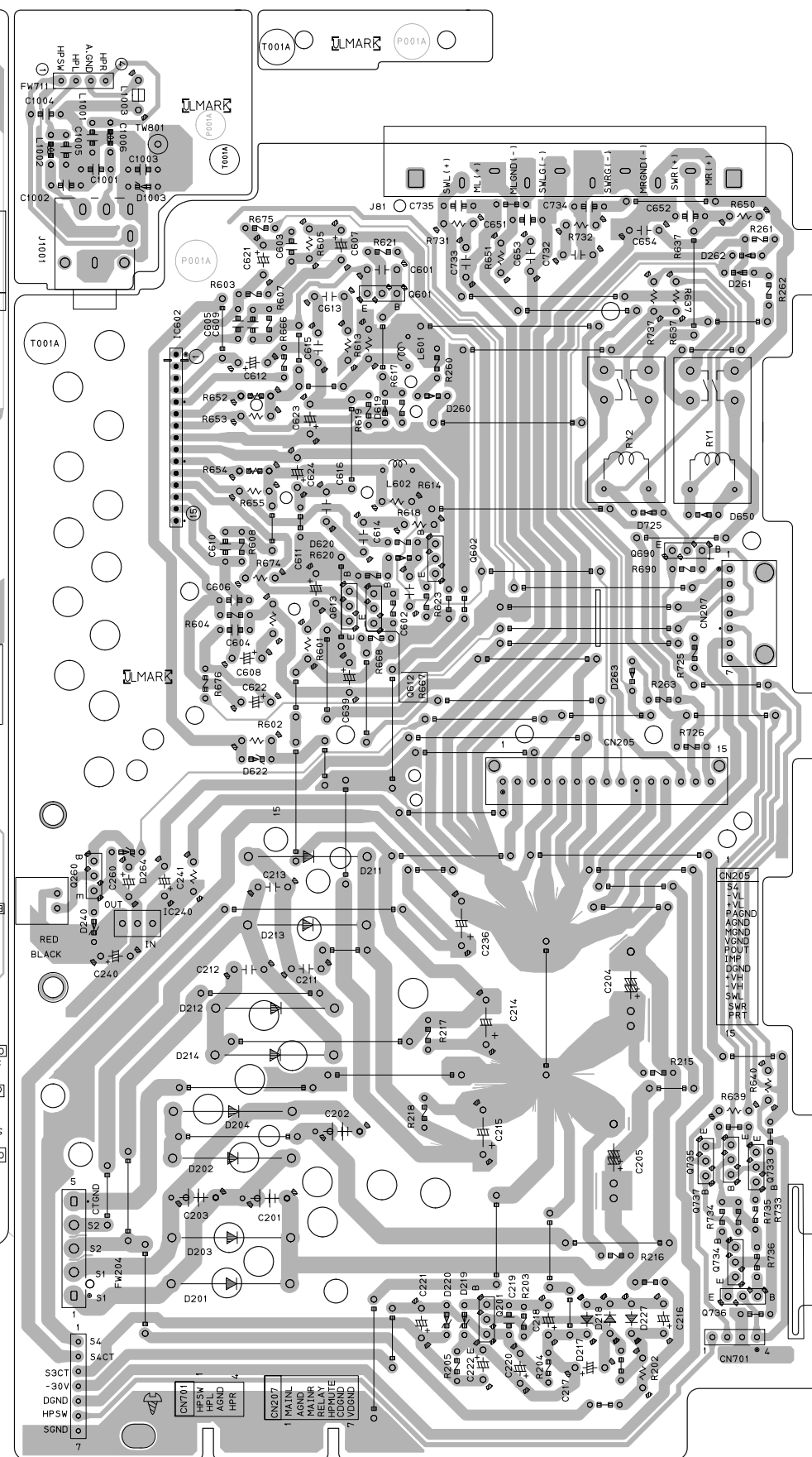
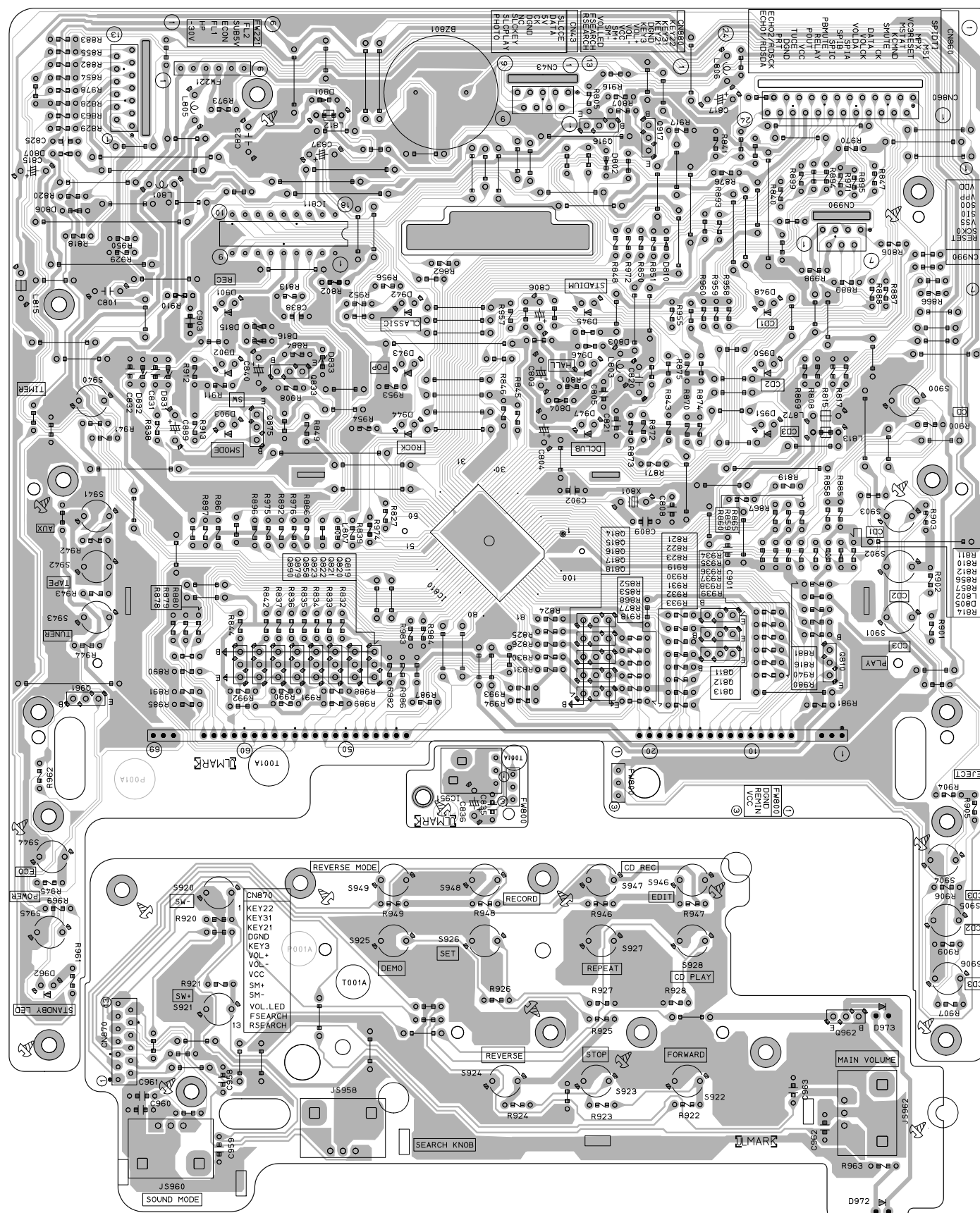

A

B

C

D

E

F

G

■ Power amplifier board

5

4

3

2

1

A

B

C

2-12 D

E

F

G

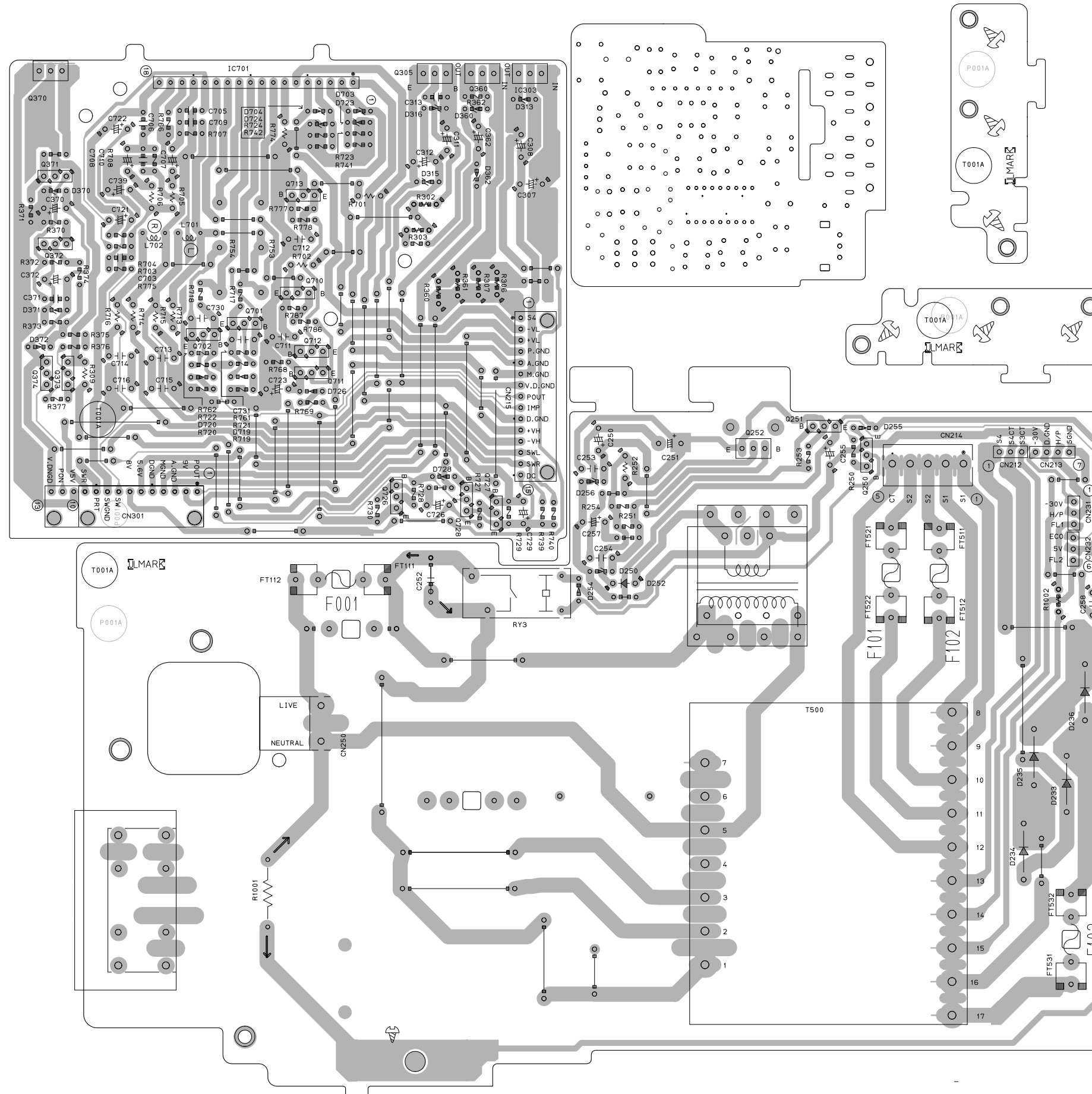

CD servo control board

5
4
3
2
1

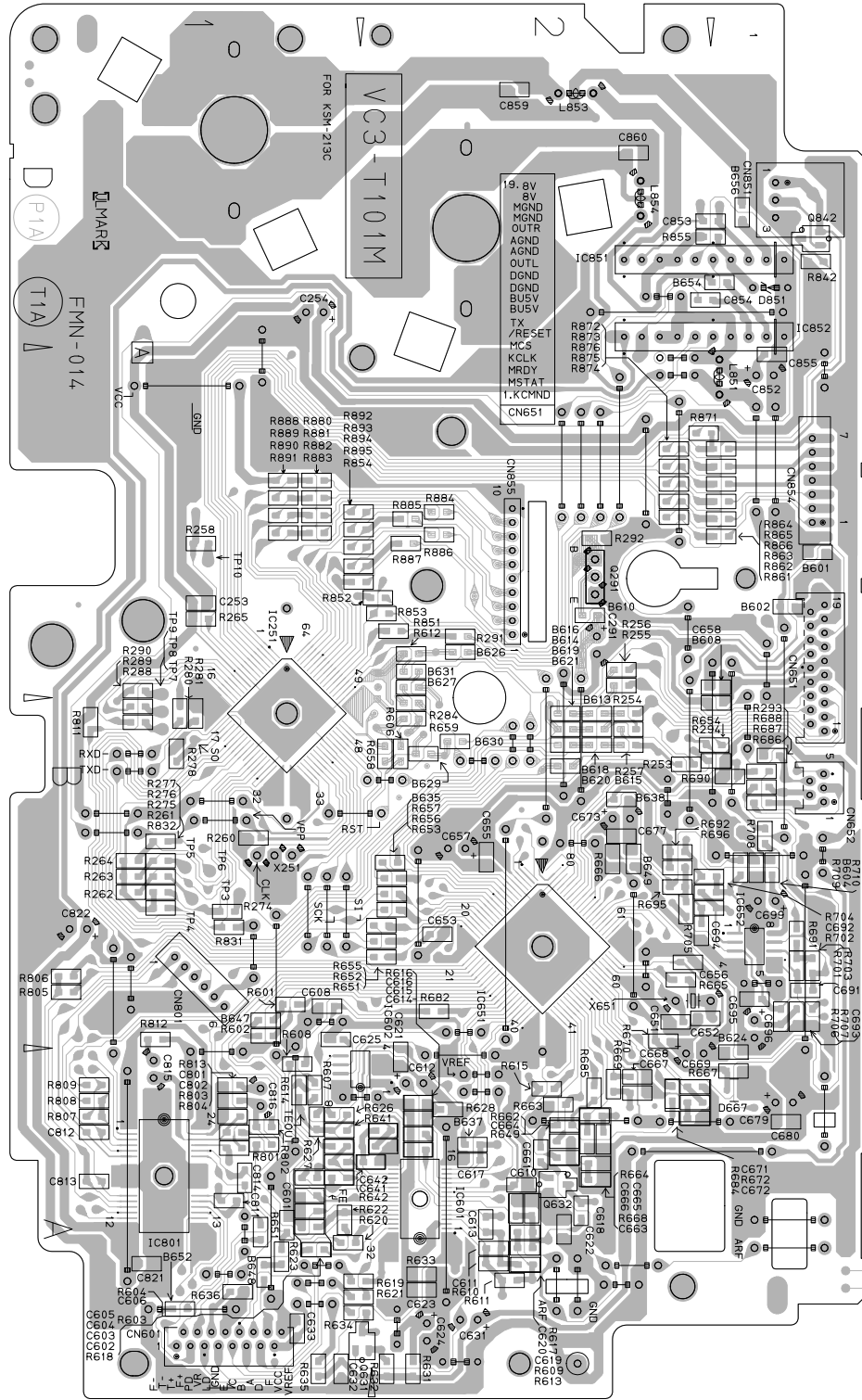

■ Tuner board

5

4

3

2

1

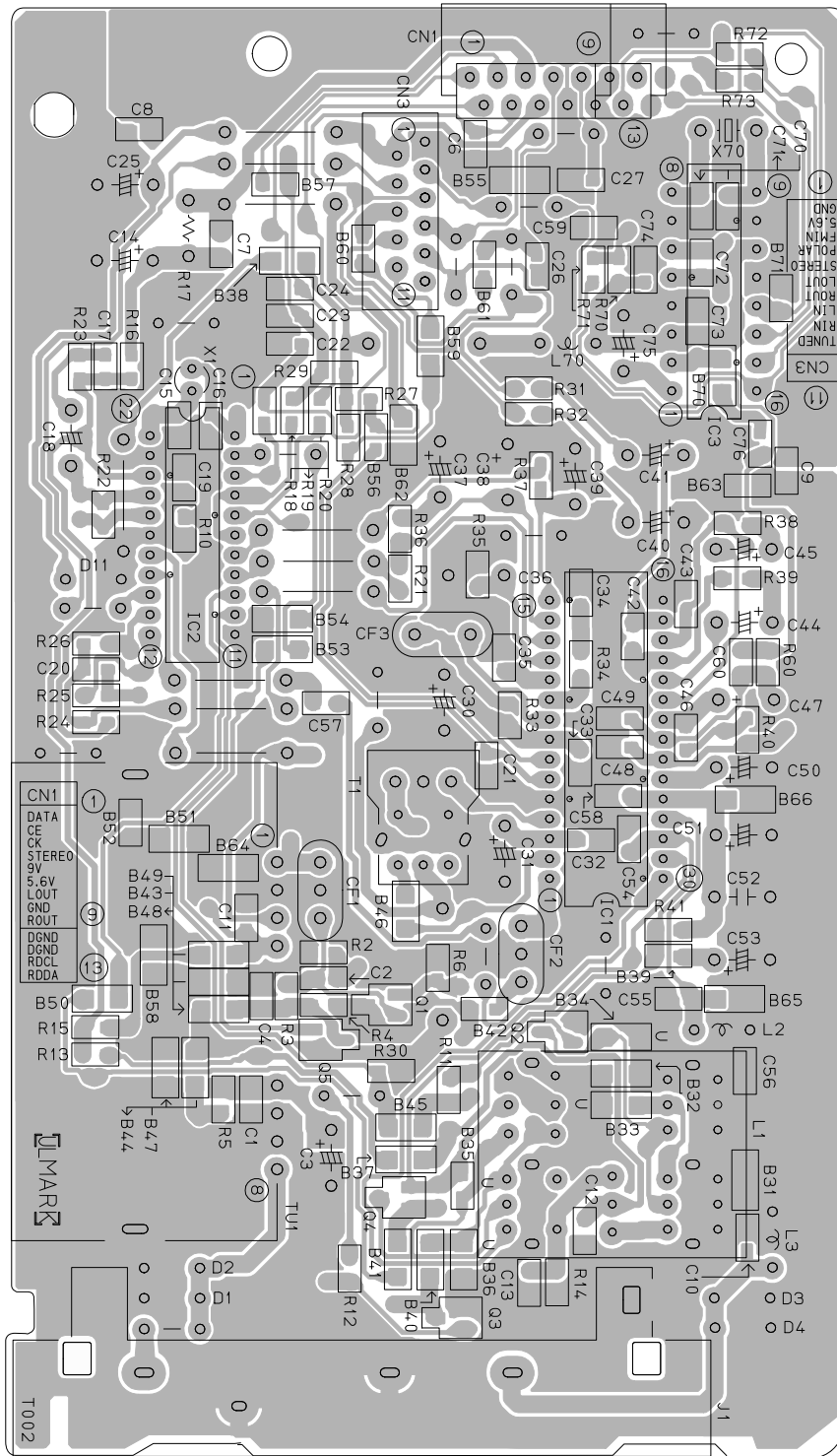

Head amplifier board

5
4
3
2
1

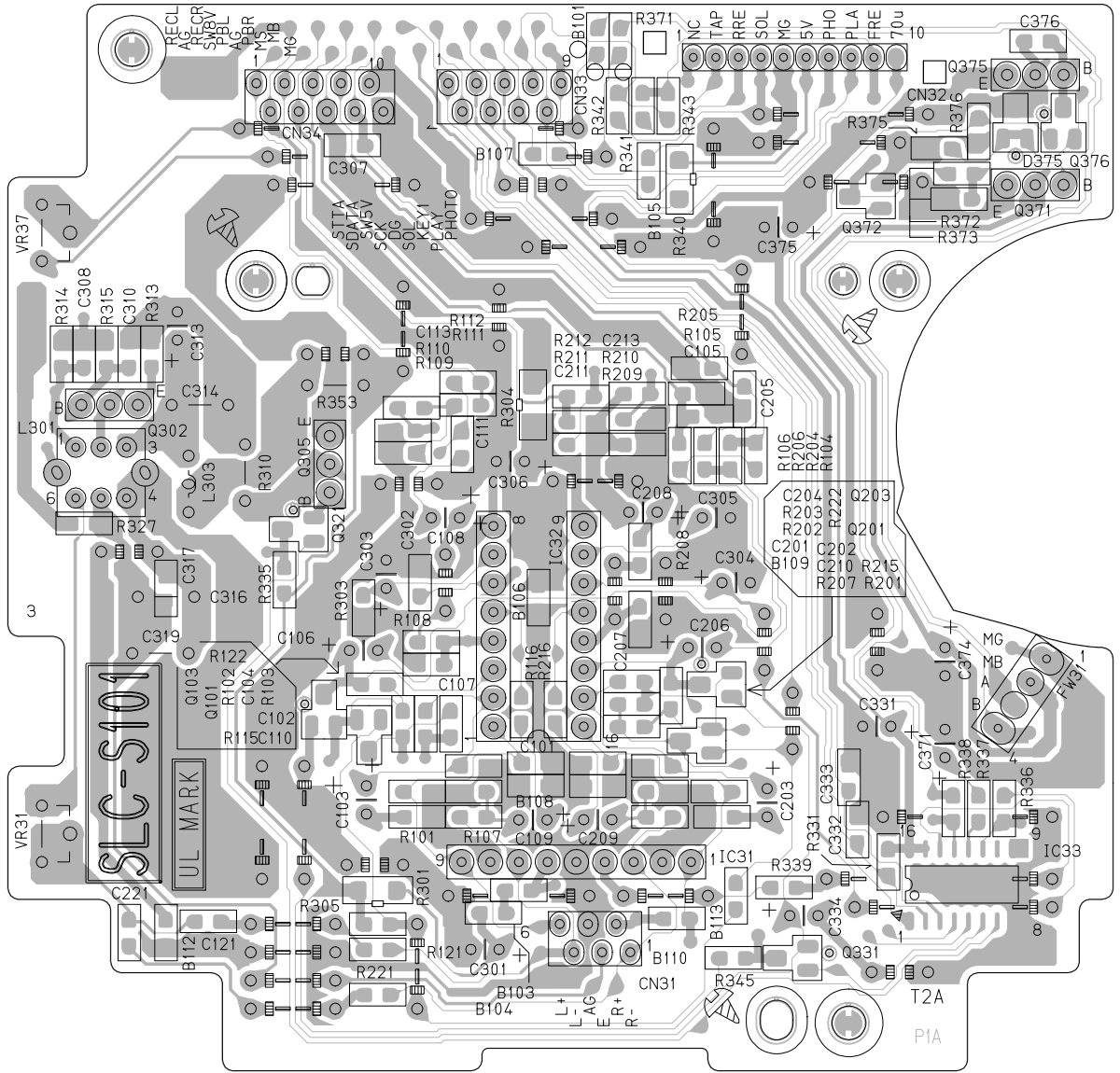

A B C 2-15

■ **Traverse mechanism board**

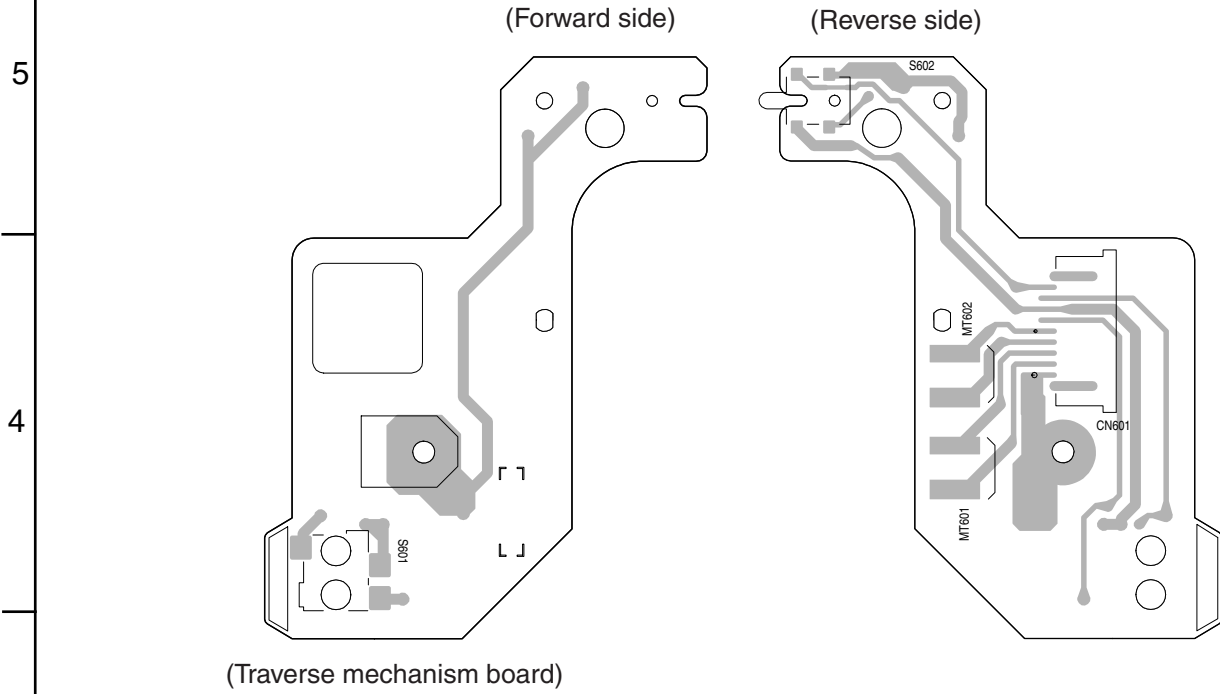

■ **Cassette switch board**

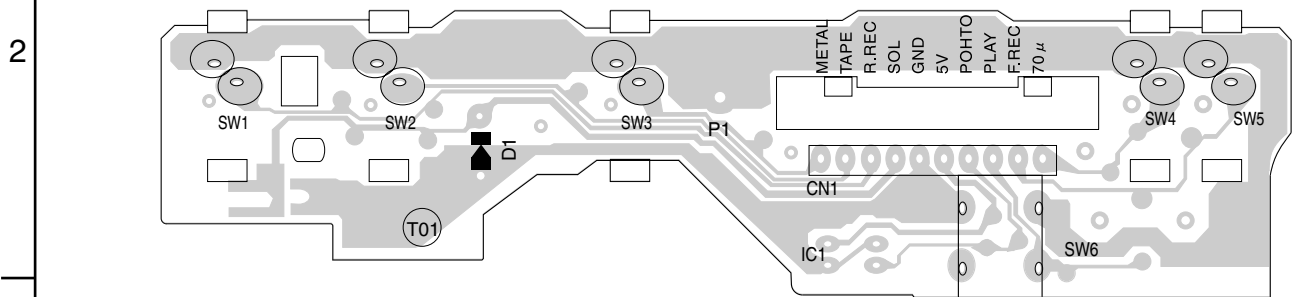



VICTOR COMPANY OF JAPAN, LIMITED
AUDIO & COMMUNICATION BUSINESS DIVISION
PERSONAL & MOBILE NETWORK BUSINESS UNIT. 10-1,1chome,Ohwatari-machi,Maebashi-city,371-8543,Japan